



Wall-mounted heat recovery air handling unit

KOMFORT EC S S11/S15 KOMFORT EC SB S11/S15

Air capacity - up to 700 m³/h
Heat recovery efficiency - up to 98 %

Use

- Air handling units for efficient supply and exhaust ventilation in flats, houses, cottages and other buildings.
- Heat recovery minimises ventilation heat losses.
- Controllable air exchange for creating the best suitable indoor microclimate.
- Compatible with round Ø125, 160, 200 mm air ducts.

Design

- The casing is made of double-skinned polymer coated steel panels, internally filled with 20 mm mineral wool layer for heat- and sound-insulation.
- The hinged panel of the casing ensures easy access to the internals for cleaning and other maintenance operations.
- The spigots for connection to the air ducts are located at the top of the unit and are rubber sealed for airtight connection to the air ducts.

Fans

- High-efficient external rotor EC-motors and centrifugal impellers with backward curved blades are used for air supply and exhaust.
- EC motors have the best power consumption to air capacity ratio and meet the latest demands concerning energy saving and high-efficient ventilation.
- EC motors are featured with high performance, low noise level and totally controllable speed range.
- Dynamically balanced impellers.

Heat recovery

- The unit is equipped with a plate counter-flow polystyrene heat exchanger with a large surface area and high heat recovery efficiency.
- Heat recovery is based on utilization of heat energy contained in the extract air stream for heating up the supply air stream. Extract air transfers most of its heat to the intake air flow. Heat recovery reduces heat energy losses in cold seasons. In summer the heat exchanger performs reverse and transfers a part of the accumulated coolness from the cooled extract air for warming up the intake air. This contributes to better performance of air conditioners in ventilated premises.
- The drain pan under the heat exchanger block is used for condensate collection and drainage. The drain pan is fitted with a drain pipe for condensate removal.
- The electronic freeze protection system is used to prevent the heat exchanger freezing in cold seasons. In case of a freezing danger registered by the temperature sensor the supply fan turns off to let the heat exchanger surface get warmed up with warm extract air flow. After a freezing danger is over the supply fan is turned on and the unit reverts to the standard operation mode.

Bypass

- The KOMFORT EC SB units are equipped with the 100% bypass for summer ventilation (room cooling by the cool intake air).

Air filtration

- Two built-in G4 panel filters provide efficient supply and extract air filtration.
- The replaceable F7 supply air filter is an additional option.

Control and automation

- KOMFORT EC S S11 / KOMFORT EC SB S11 units incorporate an integrated control system with the S11 wall-mounted control panel with an LCD display.
- KOMFORT EC S S15 / KOMFORT EC SB S15 units incorporate an integrated control system with the S15 wall-mounted control panel with a LED indication. The units are equipped with the Type B USB Connector for advanced options setting in a special software.
- The standard delivery set includes a 10 m cable for connection of the unit and the control panel.
- **S11 automation functions:**
 - Activating / deactivating the unit.
 - Setting required supply and extract fan speed for the unit air flow control. Each speed is individually adjusted during set-up.
 - Bypass damper opening / closing for summer ventilation.
 - Setting and maintaining room or duct air temperature.
 - Timer turning on/off and timer operation adjustment.
 - Setting day- and week-scheduled operation of the unit.
 - Operation control on feedback from FS1 duct humidity sensor (to be ordered separately) or from the humidity sensor in the control panel.
 - Filter clogging indication by motor meter.
 - System shutdown on signal from a fire alarm panel.
 - Controlling supply and exhaust air dampers (to be ordered separately).
 - Alarm indication with an error code indication.
 - Cooler control (to be ordered separately).
- **S15 automation functions:**
 - Activating / deactivating the unit.
 - Air capacity control (selecting low, medium or high speed).
 - Bypass damper opening / closing for summer ventilation
 - Alarm indication.
 - Filter maintenance indication.
- **Extra functions of the S15 automation with the installed software:**
 - Fan speed adjustment from 0 to 100%. Each speed is individually adjusted for the supply and the exhaust fans.
 - Operation control on feedback from FS2 duct humidity sensor (to be ordered separately).
 - Unit operation setting according to external control unit (to be ordered



separately).

- Temperature setting for freeze protection system activation.
- Control and operation adjustment of the filter maintenance timer.
- Error code indication.
- External control unit, bypass and humidity level control.
- Software version upgrading.

■ Mounting

- The units are designed for wall mounting.
- The casing is universal. The side of air ducts connection may be changed

by turning the unit by 180° and reversing the front and the back panels.



- The mounting place must provide enough space for connection to drain system and condensate drainage using the 20x32 KIT SFK kit (to be ordered separately).

■ Overall dimensions

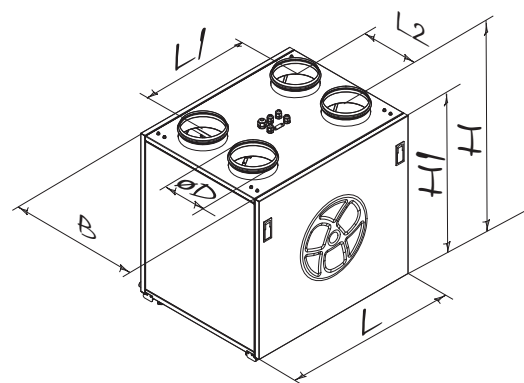
Model	Dimensions, mm						
	D	B	H	H1	L	L1	L2
KOMFORT EC S160	125	348	650	550	600	388	143
KOMFORT EC SB350	160	610	758	675	775	426	230
KOMFORT EC SB550	200	741	758	675	825	493	284



■ Accessories

Model	Replaceable filter G4 (panel)	Replaceable filter F7 (panel)	Duct humidity sensor	Condensate drainage kit
KOMFORT EC S160 S11	FP-EC S160 G4	FP-EC S160 F7	 FS1	 KIT SFK 20x32
KOMFORT EC SB350 S11	FP-EC SB350 G4	FP-EC SB350 F7		
KOMFORT EC SB550 S11	FP-EC SB550 G4	FP-EC SB550 F7		
KOMFORT EC S160 S15	FP-EC S160 G4	FP-EC S160 F7	 FS2	
KOMFORT EC SB350 S15	FP-EC SB350 G4	FP-EC SB350 F7		
KOMFORT EC SB550 S15	FP-EC SB550 G4	FP-EC SB550 F7		

Technical data

Parameters	KOMFORT EC S160	KOMFORT EC SB350	KOMFORT EC SB550
Voltage [V / 50-60 Hz]	1 ~ 230		
Unit power [W]	51	166	333
Unit current [A]	0,4	1,3	2,3
Air capacity [m ³ /h]	180	415	700
RPM	3770	3200	3230
Sound pressure level at 3 m [dBA]	24	28	28
Transported air temperature [°C]	-25 up to +60		
Casing material	polymer coated steel		
Insulation	20 mm mineral wool	40 mm mineral wool	40 mm mineral wool
Extract filter	panel G4		
Supply filter	panel G4 / F7*		
Connected air duct diameter [mm]	125	160	200
Weight [kg]	34	61	70
Heat recovery efficiency [%]**	88 up to 98	88 up to 98	81 up to 97
Heat exchanger type	counter-flow		
Heat exchanger material	polystyrene		

*option

** Heat recovery efficiency is specified in compliance with the EN308 EU norms

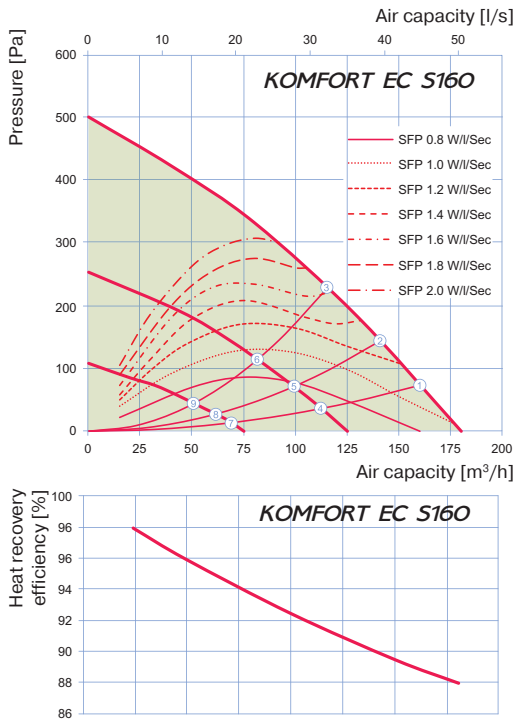

Point	Unit power [W]	Total sound pressure level at 3 m [dBA]	Total sound pressure level at 1 m [dBA]
1	50	24	34
2	51	23	33
3	50	23	33
4	22	20	30
5	22	20	30
6	21	20	30
7	9	13	23
8	9	13	23
9	9	13	23

Sound pressure level, A-weighted	Hz	Octave-frequency band [Hz]								LpA, 3 m dBA	LpA, 1 m dBA	
		Gen.	63	125	250	500	1000	2000	4000			8000
LwA to supply inlet	dBA	52	28	46	49	41	35	33	36	29	31	41
LwA to supply outlet	dBA	60	32	52	58	47	37	36	41	35	39	49
LwA to exhaust inlet	dBA	51	27	45	49	41	36	32	35	29	31	41
LwA to exhaust outlet	dBA	60	31	50	59	48	36	36	41	32	39	49
LwA to environmet	dBA	45	25	41	42	34	31	28	27	22	24	34

*Data provided for point 1 of the air flow diagram

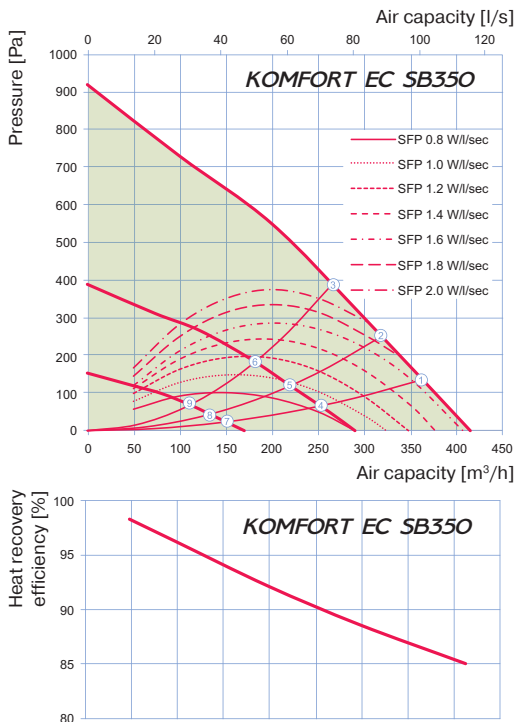

Sound pressure level, A-weighted	Hz	Octave-frequency band [Hz]								LpA, 3 m dBA	LpA, 1 m dBA	
		Gen.	63	125	250	500	1000	2000	4000			8000
LwA to supply inlet	dBA	56	50	46	53	45	39	34	36	32	35	45
LwA to supply outlet	dBA	64	56	52	63	52	39	38	43	35	44	54
LwA to exhaust inlet	dBA	56	52	46	53	45	38	34	36	31	36	46
LwA to exhaust outlet	dBA	64	58	53	62	51	40	38	42	33	44	54
LwA to environmet	dBA	49	45	40	44	38	33	29	27	22	28	38

*Data provided for point 1 of the air flow diagram

Point	Unit power [W]	Total sound pressure level at 3 m [dBA]	Total sound pressure level at 1 m [dBA]
1	165	28	38
2	165	27	37
3	165	27	37
4	63	23	33
5	62	22	32
6	60	22	32
7	21	15	25
8	20	14	24
9	20	14	24

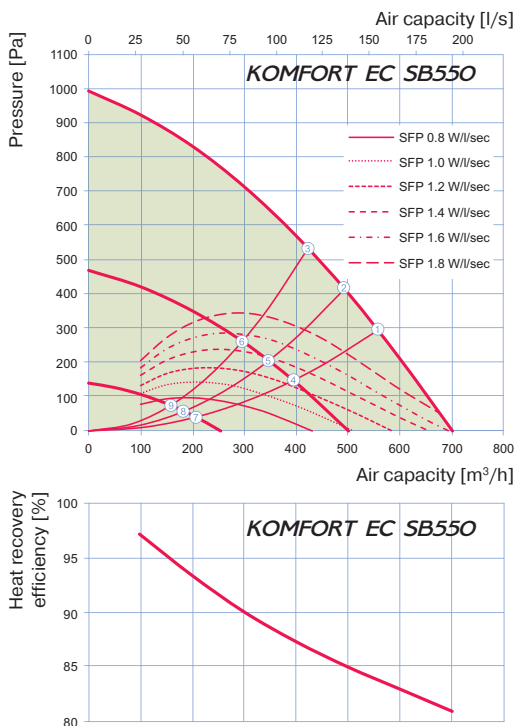

Sound pressure level, A-weighted	Hz	Octave-frequency band [Hz]								LpA, 3 m dBA	LpA, 1 m dBA	
		Gen.	63	125	250	500	1000	2000	4000			8000
LwA to supply inlet	dBA	57	50	45	54	46	42	42	42	32	36	46
LwA to supply outlet	dBA	62	59	47	58	51	43	41	43	39	42	52
LwA to exhaust inlet	dBA	56	48	43	54	45	35	34	36	32	35	45
LwA to exhaust outlet	dBA	62	58	47	59	51	43	40	43	37	41	51
LwA to environmet	dBA	49	44	39	45	38	33	30	28	23	28	38

*Data provided for point 1 of the air flow diagram

Point	Unit power [W]	Total sound pressure level at 3 m [dBA]	Total sound pressure level at 1 m [dBA]
1	332	28	38
2	331	28	38
3	332	27	37
4	133	23	33
5	129	23	33
6	126	22	32
7	32	15	25
8	31	15	25
9	30	14	24